

ICOM

INSTRUCTION MANUAL

VHF TRANSCEIVER

**IC-F3102D**

UHF TRANSCEIVER

**IC-F4102D**

Icom Inc.

**MDC 1200  
Compatible**

Limited functions only

**iDAS**  
ICOM DIGITAL ADVANCED SYSTEM

Limited functions only



The photo shows the VHF transceiver.

---

# FOREWORD

---

**READ ALL INSTRUCTIONS** carefully and completely before using the transceiver.

**SAVE THIS INSTRUCTION MANUAL**— This instruction manual contains important operating instructions for the **IC-F3102D VHF TRANSCEIVER** and the **IC-F4102D UHF TRANSCEIVER**.

---

## EXPLICIT DEFINITIONS

---

WORD	DEFINITION
<b>⚠ DANGER!</b>	Personal death, serious injury or an explosion may occur.
<b>⚠ WARNING!</b>	Personal injury, fire hazard or electric shock may occur.
<b>CAUTION</b>	Equipment damage may occur.
<b>NOTE</b>	If disregarded, inconvenience only. No risk of personal injury, fire or electric shock.

---

# VOICE CODING TECHNOLOGY

---

The AMBE+2™ voice coding Technology embodied in this product is protected by intellectual property rights including patent rights, copyrights and trade secrets of Digital Voice Systems, Inc. This voice coding Technology is licensed solely for use within this Communications Equipment. The user of this Technology is explicitly prohibited from attempting to extract, remove, decompile, reverse engineer, or disassemble the Object Code, or in any other way convert the Object Code into a human-readable form. U.S. Patent Nos.

#5,870,405, #5,826,222, #5,754,974, #5,701,390, #5,715,365,  
#5,649,050, #5,630,011, #5,581,656, #5,517,511, #5,491,772,  
#5,247,579, #5,226,084 and #5,195,166.

---

# PRECAUTIONS

---

⚠ **DANGER! NEVER** short the terminals of the battery pack.

⚠ **DANGER!** Use and charge only specified Icom battery packs with Icom radios or Icom chargers. Only Icom battery packs are tested and approved for use with Icom radios or charged with Icom chargers. Using third-party or counterfeit battery packs or chargers may cause smoke, fire, or cause the battery to burst.

⚠ **WARNING! NEVER** hold the transceiver so that the antenna is very close to, or touching exposed parts of the body, especially the face or eyes, while transmitting. The transceiver will perform best if the microphone is 5 to 10 cm away from the lips and the transceiver is vertical.

⚠ **WARNING! NEVER** operate the transceiver with a headset or other audio accessories at high volume levels. Hearing experts advise against continuous high volume operation. If you experience a ringing in your ears, reduce the volume level or discontinue use.

⚠ **WARNING! NEVER** operate the transceiver while driving a vehicle. Safe driving requires your full attention—anything less may result in an accident.

**CAUTION: MAKE SURE** the flexible antenna and battery pack are securely attached to the transceiver, and that the antenna and battery pack are dry before attachment. Exposing the inside of the transceiver to water will result in serious damage to the transceiver.

**DO NOT** operate the transceiver near unshielded electrical blasting caps or in an explosive atmosphere.

**DO NOT** push [PTT] when not actually intending to transmit.

**DO NOT** use or place the transceiver in direct sunlight or in areas with temperatures below  $-25^{\circ}\text{C}$  or above  $+55^{\circ}\text{C}$ .

---

---

**DO NOT** modify the transceiver. The transceiver warranty does not cover any problems caused by unauthorized modification.

**DO NOT** use harsh solvents such as benzine or alcohol when cleaning, as they will damage the transceiver surfaces.

**BE CAREFUL!** The transceiver will become hot when operating it continuously for long periods of time.

**KEEP** the transceiver away from heavy rain, and never immerse it in the water. The transceiver meets IP54\* requirements for dust-protection and splash resistance. However, once the transceiver has been dropped, dust-protection and splash resistance cannot be guaranteed because of possible damage to the transceiver's case or the waterproof seal.

\* Only when the battery pack/case and jack cover are attached.

**MAKE SURE** to turn the transceiver power OFF before connecting the supplied/optional equipment.

---

# TABLE OF CONTENTS

---

FOREWORD .....	i
EXPLICIT DEFINITIONS .....	i
VOICE CODING TECHNOLOGY .....	ii
PRECAUTIONS .....	iii, iv
TABLE OF CONTENTS .....	v, vi
<b>1 ACCESSORIES .....</b>	<b>1–4</b>
■ Supplied accessories .....	1
■ Accessory attachments .....	1
<b>2 PANEL DESCRIPTION .....</b>	<b>5–11</b>
■ Front, top and side panels .....	5
■ LED indicator .....	7
■ Programmable function keys .....	8
<b>3 BASIC OPERATION .....</b>	<b>12–24</b>
■ Turning power ON .....	12
■ Channel selection .....	13
■ Call procedure .....	14
■ Receiving and transmitting .....	15
■ Setting the microphone gain .....	18
■ Setting the squelch level .....	19
■ Setting the Beep level .....	20
■ Setting the Ringer level .....	21
■ Output power level selection .....	22
■ Priority A channel selection .....	22
■ MDC 1200 system operation .....	23
■ Lone Worker Emergency Call .....	23
■ Emergency Call .....	24
<b>4 IDAS OPERATION .....</b>	<b>25–30</b>
■ IDAS operation .....	25
■ IDAS-Trunk operation .....	25
■ Receiving a call .....	26
■ Transmitting a call .....	28

---

---

■ Position data transmission .....	30
■ Status message transmission .....	30
■ Encryption function .....	30
<b>5 BATTERY CHARGING .....</b>	<b>31–41</b>
■ Caution (for the BP-264 Ni-MH BATTERY).....	31
■ Caution (for the BP-265 Li-ion BATTERY) .....	33
■ Battery chargers .....	36
<b>6 BATTERY CASE .....</b>	<b>42</b>
■ Optional battery case (BP-263) .....	42
<b>7 OPTIONS .....</b>	<b>43–48</b>
■ VOX function .....	46
<b>8 COUNTRY CODE LIST.....</b>	<b>49</b>

**1****2****3****4****5****6****7****8**

# 1 ACCESSORIES

## ■ Supplied accessories

The following accessories are supplied with the transceiver.

Battery pack\*

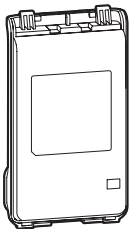

Flexible antenna  
(This illustration is for the VHF type.)

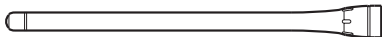

Battery charger\*

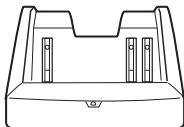

AC adapter\*

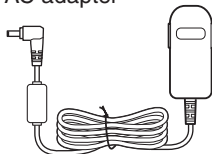

Belt clip\*



Jack cover  
(with screws)

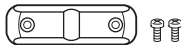

\* Not supplied, or the shape is different, depending on the version.

## ■ Accessory attachments

### ◇ Flexible antenna

Connect the flexible antenna to the antenna connector.

#### CAUTION:

- **NEVER HOLD** just the antenna when carrying the transceiver.
- Transmitting without an antenna will damage the transceiver.

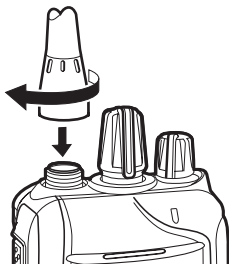



## ◇ Belt clip

### *To attach the belt clip:*

- Slide the belt clip in the direction of the arrow until the belt clip locks in place, and makes a 'click' sound.

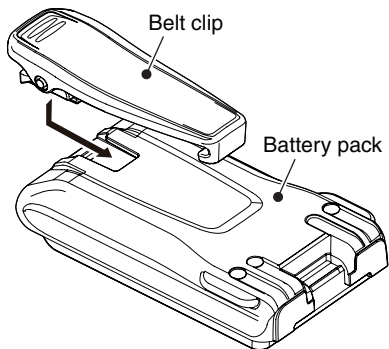

### *To detach the belt clip:*

- ① Remove the battery pack from the transceiver, if it is attached. (p. 3)
- ② Lift the tab up (①), and slide the belt clip in the direction of the arrow (②).

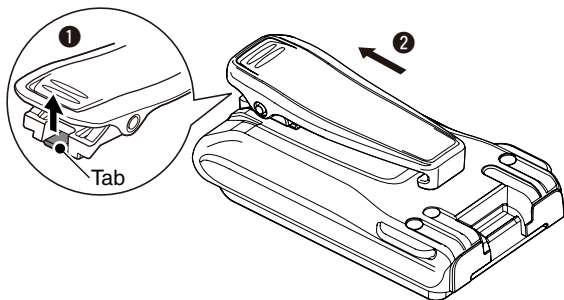

## 1 ACCESSORIES

### ◇ Battery pack or case

#### *To attach the battery pack or case:*

- ① Fit the battery pack/case in the direction of the arrow, then close it.
- ② Hook the latch until it makes a 'click' sound.

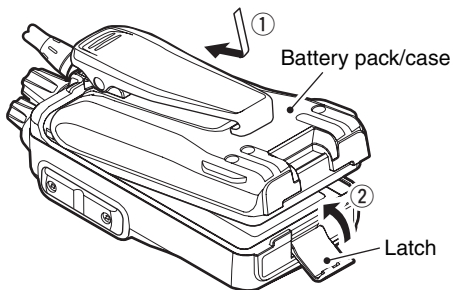

#### *To remove the battery pack/case:*

/// **Be careful!** The latch is tightly locked, so use caution when releasing it. **DO NOT** use your finger nail. Use the edge of a coin or screwdriver tip to carefully release it.

- ① Unhook the latch.
- ② Lift up the battery pack/case in the direction of the arrow.

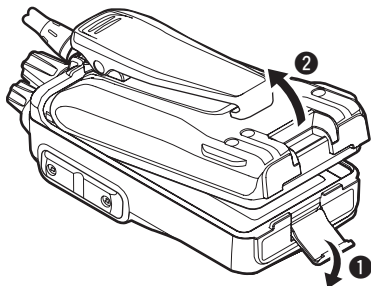

**NEVER** remove or attach the battery pack/case when the transceiver is wet or soiled. This may result in water or dust getting into the transceiver, battery pack/case, and may result in them being damaged.

**NOTE:** Keep the battery terminals clean. It's a good idea to clean the battery terminals once a week.

### ◇ Jack cover

Attach the jack cover when the optional equipment is not used.

#### *To attach the jack cover:*

- ① Attach the jack cover to the [SP MIC] jack.
- ② Tighten the screws.

#### *To detach the jack cover:*

- ① Remove the screws with a phillips screwdriver.
- ② Detach the jack cover to connect the optional equipment.

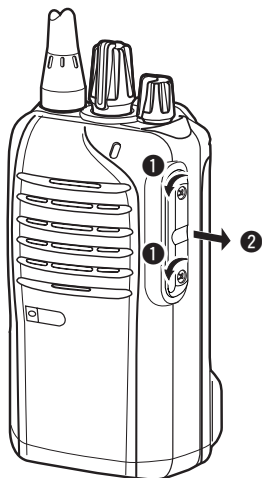
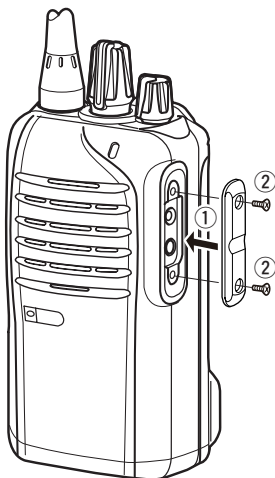

## 2 PANEL DESCRIPTION

### ■ Front, top and side panels

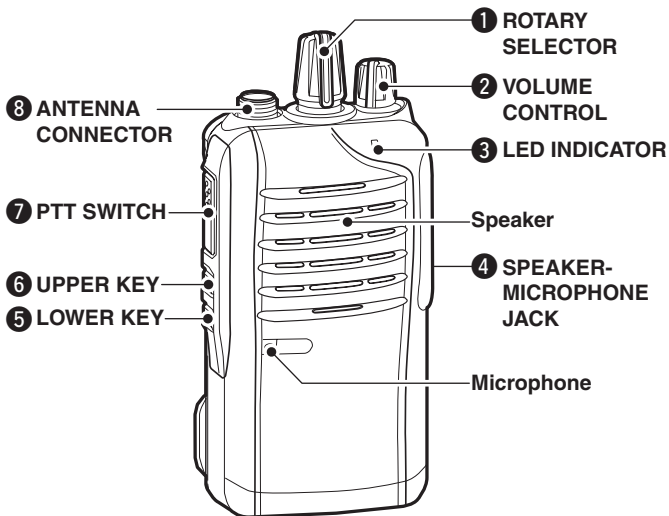

#### 1 ROTARY SELECTOR

Rotate to select the pre-programmed memory channels or scan lists, depending on the pre-programming.

#### 2 VOLUME CONTROL [VOL]

Rotate to turn the power ON or OFF, and adjust the audio level.

**3 LED INDICATOR** (p. 7)

- ➔ Lights red\* while transmitting.  
\*When the optional battery case is attached, the LED indicator lights orange.
- ➔ Lights green while receiving a signal, or when the squelch is open.
- ➔ Lights/blinks orange when the matched 2/5-tone code is received, depending on the pre-programming.

**4 SPEAKER-MICROPHONE JACK [SP MIC]**

Connect the optional speaker-microphone or VOX adapter cable.



Jack cover

**NOTE:** Attach the jack cover when the optional equipment is not used. (p. 4)

**5 LOWER KEY [Lower]****6 UPPER KEY [Upper]**

The desired function can be assigned by your dealer. (p. 8)

**7 PTT SWITCH [PTT]**

Hold down to transmit; release to receive.

**8 ANTENNA CONNECTOR**

Connect the antenna.

### ■ LED indicator

The LED indicator indicates the status of various parameters of the transceiver as follows;  
(Ref.; R=Red, G=Green, O=Orange)



- TX: Lights Red while transmitting a signal.



- RX: Lights Green while receiving a signal.

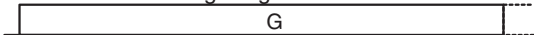

- Call LED (ON): Turns ON while receiving a matched 2/5-tone.



- Call LED (Blink): Blinks while receiving a matched 2/5-tone.



- Fast/Slow scan: Blinks when the Fast/Slow scan is activated.



- Low Battery 1: You should charge the battery. (blinks slowly)

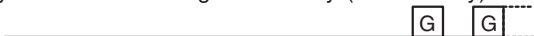

- Low Battery 2: You must charge the battery. (blinks fast)



- TX low Battery 1: Low Battery was detected during TX mode.



- TX low Battery 2: Very Low Battery was detected during TX mode.



- Channel Error: A non-programmed channel is selected.



\* Lights (or blinks) orange when the optional battery case is attached.

## ■ Programmable function keys

The following functions can be assigned to the [Upper] and [Lower] programmable function keys.

Consult your Icom dealer or system operator for details concerning your transceiver's programming.

### **SCAN**

Push to start and cancel the scanning operation.

- When the scan started with the Power ON Scan or Auto Scan function, push to pause the scanning operation. The paused scan resumes after the specified time period has passed.

### **PRIORITY A CHANNEL, PRIORITY B CHANNEL**

Push to select the Priority A or Priority B channel.

### **PRIORITY A CHANNEL (REWRITE),**

### **PRIORITY B CHANNEL (REWRITE)**

- Push to select the Priority A or Priority B channel.
- Hold down [Prio A (Rewrite)] or [Prio B (Rewrite)] for 1 second to assign the operating channel to Priority A or Priority B channel, respectively.

### **MEMORY CHANNELS 1, 2, 3, 4**

Push to directly select memory channel 1, 2, 3 or 4, if programmed. Consult your dealer for details.

### **LONE WORKER** (p. 23)

- Push to turn the Lone Worker function OFF.
- Hold down to turn the Lone Worker function ON.
  - When the Lone Worker function is turned ON, and no operation is performed for the specified time period, the Emergency function is automatically turned ON.

---

## 2 PANEL DESCRIPTION

### **MONITOR, MONITOR (AUDIBLE)**

- Push to turn the CTCSS (DTCS) or 2/5-tone squelch Mute ON or OFF.
    - Only during LMR operation, push to open any squelch functions, or deactivate any mute functions.
    - Only during PMR operation, push to activate one or two of the following functions\* on each channel.
      - Hold down to un-mute the channel (Audible mode).
      - Push to mute the channel (Inaudible mode).
      - Push to send a 'reset code' after the communication is finished.
  - \*Ask your dealer for details.
-  **NOTE:** The un-mute condition may automatically return to the mute condition, after a specified time period.
- Depending on the presetting, holding down this key for 1 second cancels a scan.

### **LOCK**

Hold down to electronically lock all programmable keys except [Moni(Audi)], [Call] (including Call A and Call B), [Emergency], [Surveillance] and [Lone Worker].

### **HIGH/LOW** (p. 22)

Select the transmit output power level temporarily or permanently, depending on the presetting.

- Ask your dealer for the output power level for each selection.

### **TALK AROUND**

- Push to turn the Talk Around function OFF.
- Hold down to turn the Talk Around function ON.
  - The Talk Around function equalizes the transmit frequency to the receive frequency for transceiver-to-transceiver communication.

### **DTMF AUTODIAL**

Push to transmit a programmed DTMF code.



### **WIDE/NARROW**

- Push to switch the IF bandwidth to Wide.
  - The wide passband width can be selected from 20 or 25 kHz using the optional cloning software (PMR operation only). Ask your dealer for details.
- Hold down to switch the IF bandwidth to Narrow.

### **CALL, CALL A, CALL B**

Push to transmit a 2/5-tone code.

- Tone call transmission may be necessary before you call another station, depending on your signalling system.
- [Call A] and/or [Call B] keys may be available when your system employs selective 'Individual/Group' calls. Ask your dealer which call is assigned to each key.

### **EMERGENCY**

Hold down for specified time period to transmit an emergency call.

- The emergency call transmits with beeps, and the LED lights red.
- The transceiver can transmit an emergency call without the beep sounding and the LED indicator lighting. Ask your dealer for details.
- If you want to cancel the emergency call, hold down the key again before transmitting the call.
- The emergency call is transmitted one time only, or repeatedly until receiving an acknowledgement signal, or until the power is turned OFF.  
**When a matched 5-tone code signal is received, the emergency function can be cancelled depending on the presetting. (PMR operation only)**

### **SURVEILLANCE**

- Push to turn the Surveillance function OFF.
- Hold down to turn the Surveillance function ON.
  - When this function is turned ON, the beep is not heard and the LED does not light when a signal is received, or a key is pushed.

---

## 2 PANEL DESCRIPTION

### **SIREN**

Hold down for 1 second to emit a siren sound.

This function can be used for situations other than an emergency alert, such as a security alarm for example.

The transceiver emits the siren sound until the power is turned OFF.

### **ENCRYPTION**

Push to turn the Voice Encryption function ON or OFF while operating in the digital mode.

### **ANNOUNCE**

Push to turn the Channel Announce function ON or OFF.

- When this function is turned ON, the transceiver announces the position of [ROTARY SELECTOR] between 1 and 16 when rotating [ROTARY SELECTOR] to a desired scale.

# BASIC OPERATION 3

## ■ Turning power ON

▨ Prior to using the transceiver for the first time, the battery pack must be fully charged for optimum life and operation. (p. 31)

➔ Rotate [VOL] to turn power ON.

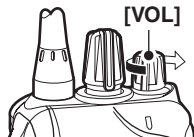

## ◇ Battery type selection

The battery type must be selected according to the battery pack or case when it is changed, but only the first time it is used.

Check the battery type before you begin the selection procedure.

One to three beep(s) sound in sequence, so you must repeat the steps until the number of beeps matches your battery type.

For example, if your battery type is a Li-ion battery pack, you must repeat the procedure until one beep is heard.

- ① Set [ROTARY SELECTOR] to any channel other than Channel 16.
- ② Rotate [VOL] to turn OFF the transceiver's power.
- ③ While holding down [PTT], rotate [VOL] to turn ON the power.
  - You should hold [PTT] until the beep sounds. (It takes approximately 5 second.)
  - One beep sounds when the Li-ion battery is selected.
  - Two beeps sound when the battery case is selected.
  - Three beeps sound when the Ni-MH battery is selected.
- ④ After the beep sounds, release [PTT].
- ⑤ Repeat steps ② to ④ until you select the attached battery type.

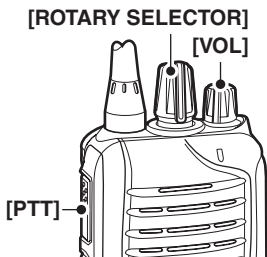

▨ **NOTE:** This operation may not be available, depending on the presetting. Ask your dealer for details.

## ■ Channel selection

Several types of channel selecting methods are available. They may differ, according to your system set up.

To select a desired operating channel, do one of the following.

- Rotate [ROTARY SELECTOR].
- Push one of memory channel keys, [MR-CH 1] to [MR-CH 4].
- Push one of these keys, [Prio A], [Prio B], [Prio A (Rewrite)] and [Prio B (Rewrite)].

### ***AUTOMATIC SCAN TYPE:***

Selecting a channel is not necessary for this type. When turning ON the power, the transceiver automatically starts scanning. Scanning stops when a call is received.

/// **NOTE:** If the Move to Priority A channel at Power ON function (p. 22) is turned ON, the transceiver does not start scanning at power ON.

## ■ Call procedure

When your system employs tone signalling (excluding CTCSS and DTCS), the tone call procedure may be necessary prior to voice transmission. The tone signalling that is employed in the transceiver may be a selective calling system, which allows you to call only specific station(s), and prevent unwanted stations from contacting you.

- ① Select a desired TX code channel or 2/5-tone code, according to your System Operator's instructions.
  - This may not be necessary, depending on programming.
- ② Push [Call] (assigned to one of the dealer programmable keys.) (p. 10)
- ③ After transmitting a 2/5-tone code, the remainder of your communication can be carried out normally.

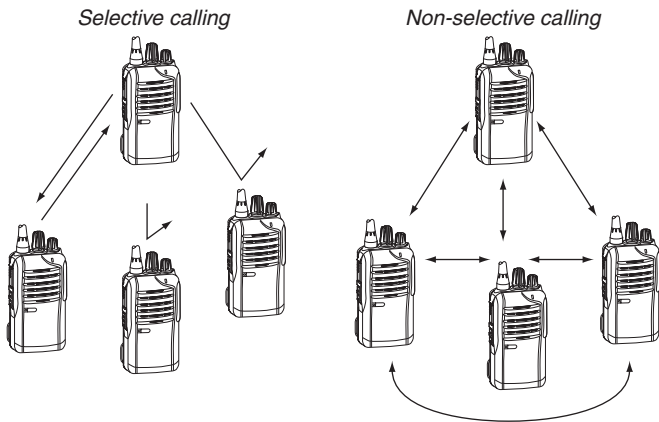

## ■ Receiving and transmitting

/// **CAUTION:** Transmitting without an antenna will damage the transceiver. See page 1 for antenna attachment.

### ***Receiving:***

- ① Rotate [VOL] to turn ON the power.
- ② Rotate [ROTARY SELECTOR], or push one of the memory channel keys, [MR-CH 1] to [MR-CH 4], to select a channel.
- ③ When receiving a call, adjust the audio output to a comfortable listening level.

/// **NOTE:** When a matched RX code signal is received, audio from the microphone is automatically transmitted for a specified time period.\*

/// \* Depending on the presetting. Ask your dealer for details.

### ***Transmitting:***

Wait for the channel to become clear to avoid interference.

- ① While holding down [PTT], speak into the microphone at a normal voice level.
- ② Release [PTT] to return to receive.

/// **IMPORTANT:** To maximize the readability of your signal;

1. Pause briefly after pushing [PTT].
2. Hold the microphone 5 to 10 cm (2 to 4 inches) from your mouth, then speak into the microphone at a normal voice level.

## ◇ Transmitting notes

### • Transmit inhibit function

The transceiver has several inhibit functions, which restrict transmission under the following conditions:

- The channel is muted. (PMR operation only)
- The channel is busy.
- A signal with the un-matched (or matched) CTCSS (or DTCS) tone is received.
- The selected channel is a 'receive only' channel.

### • Time-out timer

After continuously transmitting longer than the pre-programmed time period, the time-out timer activates, and stops further transmitting.

### • Penalty timer

Once the time-out timer activates, transmitting is further inhibited for a time period determined by the penalty timer.

### • PTTID call

The transceiver automatically sends the ID code (5-tone, DTMF, BIIS, MDC system or IDAS operations) when [PTT] is pushed (beginning of the transmission) and/or released (end of transmission), depending on the presetting.

---

### 3 BASIC OPERATION

#### ◇ **DTMF transmission**

If the transceiver has [DTMF Autodial] assigned to it, the automatic DTMF transmission function is usable.

➡ Push [DTMF Autodial] to transmit the DTMF code.

#### ◇ **Receiving a Stun, Kill and Revive command**

The dispatcher can send a 2/5-tone signal that will stun, kill or revive your transceiver.

When the Stun command is received, a beep sounds\*, and the transceiver becomes unusable. Receiving a Revive command is necessary to operate the transceiver again in this case.

When the Kill command is received, a beep sounds\*, and the transceiver becomes unusable (the transceiver switches to the cloning required condition). Cloning the transceiver is necessary to operate the transceiver again in this case.

\* Depending on the presetting. Ask your dealer for details.



## ■ Setting the microphone gain

Adjusts the microphone gain.

- ① Rotate [VOL] to turn the transceiver power OFF.
- ② Set [ROTARY SELECTOR] to Channel 16.
- ③ While holding down [Upper], rotate [VOL] to turn ON the power and enter the microphone gain adjustment mode.
- ④ Push [Upper] to increase, or push [Lower] to decrease the microphone gain.

- The adjustable range is 1 (minimum) to 4 (maximum).
- A beep sounds after pushing [Upper] or [Lower].

An error beep sounds if you try to decrease more than 1 or try to increase more than 4.

Therefore, you can determine the current level setting by the type of beep that sounds.

- ⑤ Rotate [VOL] to turn the power OFF, then ON again to exit the microphone gain adjustment mode.

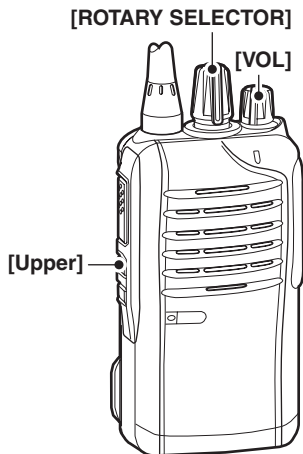

### NOTE:

- This operation may not be available, depending on the presetting. Ask your dealer for details.
- When using the VOX function, we recommend setting the microphone gain to 3. However, you can adjust it to suit your operating environment (including your headset performance).

## ■ Setting the squelch level

The squelch circuit mutes the received audio signal, depending on the signal strength.

- ① Rotate [VOL] to turn the transceiver power OFF.
- ② Set [ROTARY SELECTOR] to any channel other than Channel 16.
- ③ While holding down [Upper], rotate [VOL] to turn ON the power and enter the squelch level adjustment mode.
- ④ Push [Upper] to increase the squelch level (tight squelch), or push [Lower] to decrease the squelch level (loose squelch).
  - The adjustable range is 0 (loose squelch) to 9 (tight squelch).
  - A beep sounds after pushing [Upper] or [Lower].

An error beep sounds if you try to decrease more than 0 or try to increase more than 9.

Therefore, you can determine the current level setting by the type of beep that sounds.

- ⑤ Rotate [VOL] to turn the power OFF, then ON again to exit the squelch level adjustment mode.

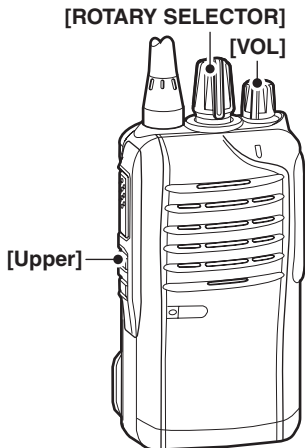

**NOTE:** This operation may not be available, depending on the presetting. Ask your dealer for details.

## ■ Setting the Beep level

The beep function can be turned ON or OFF, and its level can be adjusted between 1 and 5, or 1 (linked) and 5 (linked). When a Linked option is selected, the beep level is adjustable with [VOL].

- ① Rotate [VOL] to turn the transceiver power OFF.
- ② Set [ROTARY SELECTOR] to any channel other than Channel 16.
- ③ While holding down [Lower], rotate [VOL] to turn ON the power and enter the beep level adjustment mode.
- ④ Push [Upper] to change the beep level, or push [Lower] to turn the beep function ON or OFF.
  - The adjustable range is 1 to 5 or 1 (Linked) to 5 (Linked).
  - If the level is set on 1 to 4 or 1 (Linked) to 4 (Linked), pushing [Upper] increases the level.
  - If the level is 5 or 5 (Linked), 1 (Linked) or 1 is selected after pushing [Upper], respectively.
  - A beep sounds after pushing [Upper]. Therefore, you can determine the current level setting by the type of beep that sounds.
  - One beep sounds when the beep function is turned ON after pushing [Lower].
- ⑤ Rotate [VOL] to turn the power OFF, then ON again to exit the beep level adjustment mode.

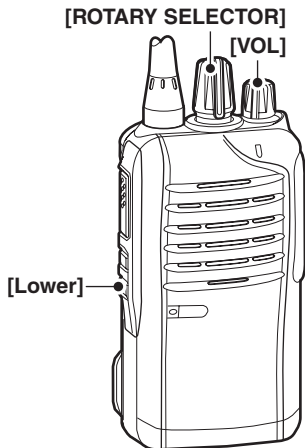

**NOTE:** This operation may not be available, depending on the presetting. Ask your dealer for details.

## ■ Setting the Ringer level

The Ringer level can be adjusted between 1 and 5, or 1 (Linked) and 5 (Linked). When a Linked option is selected, the Ringer level is adjustable with [VOL].

- ① Rotate [VOL] to turn the transceiver power OFF.
- ② Set [ROTARY SELECTOR] to Channel 16.
- ③ While holding down [Lower], rotate [VOL] to turn ON the power and enter the Ringer level adjustment mode.
- ④ Push [Upper] to increase, or push [Lower] to decrease the Ringer level.
  - The adjustable range is 1 to 5 or 1 (Linked) to 5 (Linked).
  - If the level is set on 5 or 5 (Linked), pushing [Upper] selects 1 (Linked) or 1, respectively. If the level is 1 or 1 (Linked), pushing [Lower] selects 5 (Linked) or 5, respectively.
  - A beep sounds after pushing [Upper] or [Lower]. Therefore, you can determine the current level setting by the type of beep that sounds.
- ⑤ Rotate [VOL] to turn the power OFF, then ON again to exit the beep level adjustment mode.

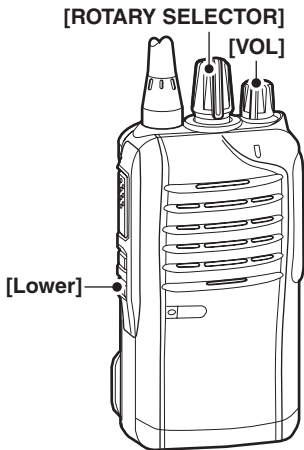

**NOTE:** This operation may not be available, depending on the presetting. Ask your dealer for details.

## ■ Output power level selection

If the transceiver has [High/Low] assigned to it, the transmit output power level can be selected, depending on the presetting.

When the battery case is selected as the battery type, or the battery voltage drops to a low power level and the LED indicator status is “Low Battery 2,” the output power automatically switches to “Low 1.” (pp. 7, 12)

- Push [High/Low] to select the transmit output power level.
  - One beep sounds when “Low 1” is selected.
  - Two beeps sound when “Low 2” is selected.
  - Three beeps sound when “High” is selected.

## ■ Priority A channel selection

When one of the following operations is performed, the transceiver automatically selects the Priority A channel.

- Turning the power ON  
The Priority A channel is selected each time the transceiver power is turned ON.
- Auto reset  
The Priority A channel is selected when the Auto Reset timer ends.

## ■ MDC 1200 system operation

The MDC 1200 signaling system enhances your transceiver's capabilities. It allows PTT ID\* and Emergency signaling.

\*When [PTT] is pushed and/or released, the transceiver transmits your station ID.

### ◇ Transmitting an Emergency Call

The MDC 1200 system's Emergency feature can be accessed using the [Emergency] key. The transceiver will send an Emergency MDC 1200 system command once, or repeatedly for a programmed number of times until it receives an acknowledgement signal.

The emergency call can be transmitted without a beep sound, depending on how the emergency function is programmed. Ask your dealer for details.

## ■ Lone Worker Emergency Call

When the Lone Worker function is turned ON, and no operation is performed for the specified time period\*, the transceiver enters the emergency mode, and then the countdown for the emergency call transmission starts.

After the specified time period\* has passed, an emergency call is automatically transmitted once, or repeatedly\*.

If someone operates the transceiver before the call is transmitted, the transceiver exits the emergency mode, and the emergency call is cancelled.

\* Depending on the presetting. Ask your dealer for details.

- ① Hold down [Lone Worker] to turn ON the Lone Worker function.
- ② Push [Lone Worker] to turn OFF the Lone Worker function.

## ■ Emergency Call

When [Emergency] is held down for the specified time period\*, the emergency signal is transmitted once, or repeatedly, on the specified emergency channel.

A repeat emergency signal is automatically transmitted until you turn the power OFF.

Depending on the pre-programmed settings, receiving a matching 5-tone code cancels the transmission.

When no emergency channel is specified, the signal is transmitted on the previously selected channel.

If you want to cancel the emergency call, hold down [Emergency] again before transmitting the call.

If your transceiver is programmed for Silent operation, you can transmit an Emergency call without the beep sounding and the LED indicator lighting.

 **IMPORTANT:** It is recommended to set an emergency channel individually to provide the certain emergency call operation.

### ◇ NOTES

Depending on the presetting, the following functions are automatically activated. Ask your dealer for details.

#### • Auto TX function

After the emergency call transmission, audio from the microphone is automatically transmitted for a specified time period.\*

#### • Auto RX function

After the emergency call transmission, the transceiver stands by in the audible mode for the specified time period.\*

\* Depending on the presetting. Ask your dealer for details.

# 4 IDAS OPERATION

---

## ■ IDAS operation

The IC-F3102D and IC-F4102D provide Icom Digital Advanced System (IDAS) that meets the 6.25 kHz emission mask requirements for narrow banding, and increases efficiency of channel allocation and use of spectrum.

 **NOTE:** During IDAS operation, BIIS 1200 and MDC 1200 system operations are not available.

## ■ IDAS-Trunk operation

The IDAS-Trunk system enables further effective channel management by sharing a minimum of channels with a large number of users.

Rotate [ROTARY SELECTOR] to select the memory channel that is programmed in the IDAS-Trunk zone.

 **NOTE:** During IDAS-Trunk operation, you can receive and transmit digital calls in the same way with the following IDAS operation.



## ■ Receiving a call

### ◇ Receiving a Call Alert

- ① When a Call Alert is received;
  - The transceiver will automatically transmit the acknowledgement.
  - The LED indicator blinks orange.
  - Beeps sound.
- ② Hold down [PTT], then speak into the microphone.
- ③ Release [PTT] to receive a response.

 **NOTE:** The LED indicator or Beeps may differ, depending on the presetting. Ask your dealer for details.

### ◇ Receiving a Stun, Kill or Revive

If an individual call with Stun or Kill command is received (RAN code matching is not necessary depending on the presetting), the transceiver will automatically transmit the acknowledgement, and then you cannot receive\* or transmit.

\* Depending on the received Stun command setting.

- When a Stun command is received;
  - The transceiver cannot be operated until the individual call with Revive command is received (RAN code matching is not necessary depending on the presetting) or until the data cloning is performed.
  - Even if [ROTARY SELECTOR] is changed, the transceiver will keep the same channel as the Stun command is received.
- When a Kill command is received;
  - The LED indicator alternately blinks red and green.
  - The transceiver cannot be operated until the data cloning is performed. Ask your dealer for details.

 **NOTE:** Depending on the presetting, the transceiver ignores the Stun, Revive and Kill commands, which are from a non-specified station.

### ◇ **Receiving a Remote Monitor or Radio Check Call**

If an individual call with Remote monitor or Radio check command is received (RAN code matching is not necessary depending on the presetting), the transceiver will automatically transmit.

- When a Remote monitor command is received;
  - The transceiver will automatically transmit the acknowledgement, and then it transmits the microphone audio for the set time period.
- When a Radio check command is received;
  - The transceiver will automatically transmit the acknowledgement.

## ■ Transmitting a call

IDAS operation allows you to make a call to a specific station (Individual call) or to a particular group (Talkgroup call). Other digital mode transceivers on the channel will not receive a call that does not match their individual or talkgroup ID and/or RAN (Radio Access Number) code.

4

### ◇ Transmitting an Emergency Call

When [Emergency] is held down for the specified time period, the emergency signal (digital command) is transmitted once or repeatedly\* on the specified emergency channel. When no emergency channel is specified, the signal is transmitted on the operating channel.

\* When the Repeat Cancel function is ON, the transceiver cancels repeating after receiving an acknowledgement.

When the Repeat Cancel function is OFF, the transceiver repeats calling according to the number of repeat cycles, even after receiving an acknowledgement.

Individual or Talkgroup call types of emergency calls can be pre-fixed. If the call type is not pre-fixed, the default or selected call type is used.

If you want to cancel the emergency call, hold down [Emergency] again before transmitting the call.

If your transceiver is programmed for Silent operation, you can transmit an Emergency call without the beep sounding and the LED indicator lighting.

The transceiver can also be programmed to keep the microphone open during an emergency call, allowing monitoring of the situation.

Ask your dealer for details.

---

## 4 IDAS OPERATION

**IMPORTANT:** It is recommended to set an emergency channel individually to provide the certain emergency call operation.

**NOTE:** The Digital Request Ack function is activated, the transceiver transmits the emergency call with the request to send back an acknowledgment.

## ■ Position data transmission

When an optional HM-171GP or any other GPS receiver is connected to the transceiver, the position (longitude and latitude) data can be transmitted automatically when;

- After sending a Status Call
  - Set the 'Send with Status Call' item as 'Enable.'
- After sending an Emergency Call
  - Set the 'Send with Emergency' item as 'Enable.'
- After sending a Voice Call
  - Set the 'Send with Voice Call' item as 'Enable.'

Ask your dealer or system operator for connection details.

## ■ Status message transmission

The status message can be transmitted automatically.

The status message is transmitted when the transceiver is turned ON or OFF.

- Select a status message to be transmitted in 'Power ON Status' or 'Power OFF Status' item, respectively.
- Select a target station ID in 'Power Status ID'.

## ■ Encryption function

The encryption function enables voice scrambling, which provides private digital communication between stations.

Push [Encryption] to turn the encryption function ON or OFF.

# 5 BATTERY CHARGING

## ■ Caution (for the BP-264 Ni-MH BATTERY)

⚠ **DANGER! NEVER** short terminals (or charging terminals) of the battery pack. Also, current may flow into nearby metal objects such as a necklace, so be careful when placing battery packs (or the transceiver) in handbags, etc.

Simply carrying with or placing near metal objects such as a necklace, etc. may cause shorting. This may damage not only the battery pack, but also the transceiver.

⚠ **DANGER! NEVER** incinerate used battery packs. Internal battery gas may cause an explosion.

⚠ **DANGER! NEVER** immerse the battery pack in water. If the battery pack becomes wet, be sure to wipe it dry **BEFORE** attaching it to the transceiver.

**CAUTION:** Always use the battery within the specified temperature range,  $-5^{\circ}\text{C}$  to  $+55^{\circ}\text{C}$ . Using the battery out of its specified temperature range will reduce the battery's performance and battery life.

**CAUTION:** Shorter battery life could occur if the battery is left completely discharged, or in an excessive temperature environment (above  $+60^{\circ}\text{C}$ ) for an extended period of time. If the battery must be left unused for a long time, it must be detached from the radio after charging. Keep it safely in a cool dry place at the following temperature range:

- $20^{\circ}\text{C}$  to  $+45^{\circ}\text{C}$  (up to a month)
- $20^{\circ}\text{C}$  to  $+35^{\circ}\text{C}$  (up to six months)
- $20^{\circ}\text{C}$  to  $+25^{\circ}\text{C}$  (up to a year\*)

\* We recommend charging the battery pack every 6 months.

**Clean** the battery terminals to avoid rust or misscontact.

**Keep** the battery terminals clean. It's a good idea to clean the battery terminals once a week.

If your Ni-MH battery pack seems to have no capacity, even after being charged, completely discharge it by leaving the power ON overnight. Then, fully charge the battery pack again. If the battery pack still does not retain a charge (or only very little charge), a new battery pack must be purchased. (p. 43)

Prior to using the transceiver for the first time, the battery pack must be fully charged for optimum life and operation.

- Recommended temperature range for charging:  
between +10°C and +40°C (rapid charge: with BC-191) or  
between 0°C and +45°C (regular charge: with BC-192)
- Use the supplied charger or optional charger (BC-191 for rapid charging, BC-192 for regular charging) only. **NEVER** use other manufacturers' chargers.

The battery pack contains a rechargeable battery.

Charge the battery pack before first operating the transceiver, or when the battery pack becomes exhausted.

If you want to prolong the battery life, the following points should be observed:

- Avoid over charging. The charging time period by the BC-192 should be less than 48 hours.
- Use the battery pack until it becomes almost completely exhausted, under normal conditions. We recommend battery charging after transmitting becomes impossible.

## ■ **Caution** (for the BP-265 Li-ion BATTERY)

Misuse of Li-ion batteries may result in the following hazards: smoke, fire, or the battery may rupture. Misuse can also cause damage to the battery or degradation of battery performance.

⚠ **DANGER! NEVER** short terminals (or charging terminals) of the battery pack. Also, current may flow into nearby metal objects such as a necklace, so be careful when placing battery packs (or the transceiver) in handbags, etc.

Simply carrying with or placing near metal objects such as a necklace, etc. may cause shorting. This may damage not only the battery pack, but also the transceiver.

### ◇ **Battery caution**

⚠ **DANGER! DO NOT** hammer or otherwise impact the battery. Do not use the battery if it has been severely impacted or dropped, or if the battery has been subjected to heavy pressure. Battery damage may not be visible on the outside of the case. Even if the surface of the battery does not show cracks or any other damage, the cells inside the battery may rupture or catch fire.

⚠ **DANGER! NEVER** use or leave battery packs in areas with temperatures above +60°C. High temperature buildup in the battery, such as could occur near fires or stoves, inside a sun heated car, or in direct sunlight may cause the battery to rupture or catch fire. Excessive temperatures may also degrade battery performance or shorten battery life.

⚠ **DANGER! DO NOT** expose the battery to rain, snow, seawater, or any other liquids. Do not charge or use a wet battery. If the battery gets wet, be sure to wipe it dry before using. The battery is not waterproof.



⚠ **DANGER! NEVER** incinerate used battery packs, since internal battery gas may cause them to rupture, or may cause an explosion.

⚠ **DANGER! NEVER** solder the battery terminals or **NEVER** modify the battery pack. This may cause heat generation, and the battery may rupture, emit smoke or catch fire.

⚠ **DANGER!** Use the battery only with the transceiver for which it is specified. Never use a battery with any other equipment, or for any purpose that is not specified in this instruction manual.

⚠ **DANGER!** If fluid from inside the battery gets in your eyes, blindness can result. Rinse your eyes with clean water, without rubbing them, and see a doctor immediately.

⚠ **WARNING!** Immediately stop using the battery if it emits an abnormal odor, heats up, or is discolored or deformed. If any of these conditions occur, contact your Icom dealer or distributor.

⚠ **WARNING!** Immediately wash, using clean water, any part of the body that comes into contact with fluid from inside the battery.

⚠ **WARNING! NEVER** put the battery in a microwave oven, high-pressure container, or in an induction heating cooker. This could cause a fire, overheating, or cause the battery to rupture.

**CAUTION:** Always use the battery within the specified temperature range,  $-20^{\circ}\text{C}$  to  $+55^{\circ}\text{C}$ . Using the battery out of its specified temperature range will reduce the battery's performance and battery life.

---

## 5 BATTERY CHARGING

**CAUTION:** Shorter battery life could occur if the battery is left fully charged, completely discharged, or in an excessive temperature environment (above +50°C) for an extended period of time. If the battery must be left unused for a long time, it must be detached from the radio after discharging.

You may use the battery until the remaining capacity is about half, then keep it safely in a cool dry place within the temperature range as shown below:

- 20°C to +50°C (up to a month)
- 20°C to +35°C (up to three months)
- 20°C to +20°C (up to a year)

### ◇ Charging caution

⚠ **DANGER! NEVER** charge the battery pack in areas with extremely high temperatures, such as near fires or stoves, inside a sun heated car, or in direct sunlight. In such environments, the safety/protection circuit in the battery will activate, causing the battery to stop charging.

⚠ **WARNING! DO NOT** charge or leave the battery in the battery charger beyond the specified time for charging. If the battery is not completely charged by the specified time, stop charging and remove the battery from the battery charger. Continuing to charge the battery beyond the specified time limit may cause a fire, overheating, or the battery may rupture.

⚠ **WARNING! NEVER** insert the transceiver (battery attached to the transceiver) into the charger if it is wet or soiled. This could corrode the battery charger terminals or damage the charger. The charger is not waterproof.

**CAUTION: DO NOT** charge the battery outside of the specified temperature range: BC-193 (+10°C to +40°C). Icom recommends charging the battery at +20°C. The battery may heat up or rupture if charged out of the specified temperature range. Additionally, battery performance or battery life may be reduced.

## Battery chargers

### ◇ Using the BC-191 to rapid charge the BP-264

The BC-191 provides rapid charging of the Ni-MH battery pack (BP-264 only). Never use for any other battery pack.

Charging time period: Approximately 2 hours (for the BP-264)

The following item is additionally required:

- An AC adapter (not supplied with some versions) or the DC power cable (OPC-515L/CP-23L).

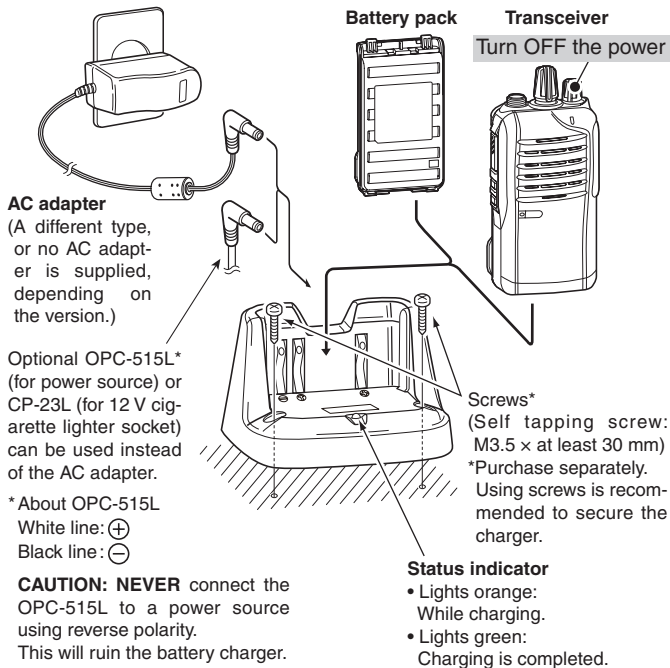

## 5 BATTERY CHARGING

### ◇ Using the BC-192 to regular charge the BP-264

The BC-192 provides regular charging of the Ni-MH battery pack (BP-264 only). Never use for any other battery pack.

Charging time period (with BC-147S): Approximately 16 hours (for the BP-264)

The following item is additionally required:

- An AC adapter (not supplied with some versions) or the DC power cable (OPC-515L).

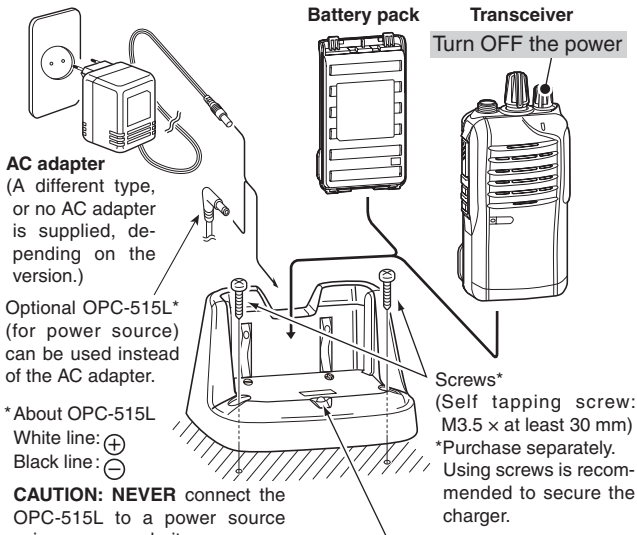

Charging time period differs depending on the input voltage.

12 V	: Approx. 36 hours
13.8 V	: Approx. 21 hours
16 V	: Approx. 16 hours

#### Status indicator

Lights green while charging.

#### NOTE:

The status indicator will not go out even after a battery pack is fully charged.

## ◇ Using the BC-193 to rapid charge the BP-265

The BC-193 provides rapid charging of the Li-ion battery pack (BP-265 only). Never use for any other battery pack.

Charging time period: Approximately 2.5 hours (for the BP-265)

The following item is additionally required:

- An AC adapter (not supplied with some versions) or the DC power cable (OPC-515L/CP-23L).

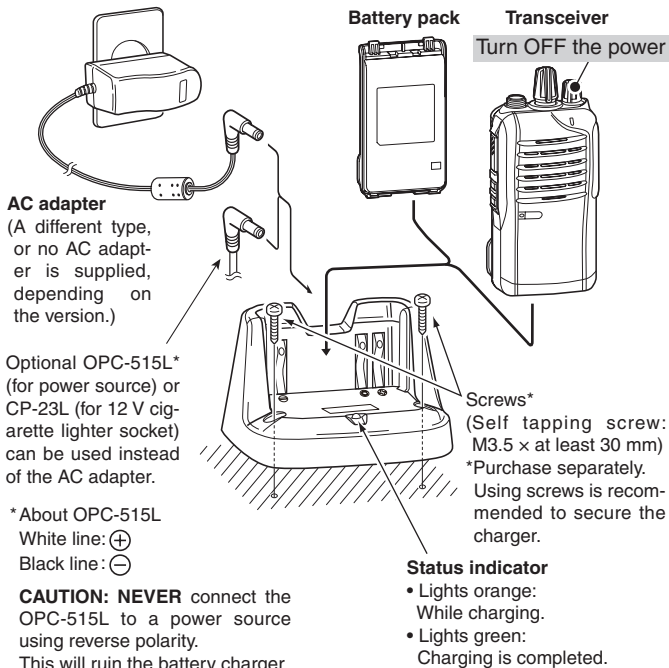

## 5 BATTERY CHARGING

### ◇ Using the BC-197 to rapid charge the BP-264 or BP-265

The BC-197 rapidly charges up to six battery packs.

Charging time for BP-264: Approximately 2 hours

Charging time for BP-265: Approximately 2.5 hours

The following additional item is required:

- An AC adapter (not supplied with some versions) or the DC power cable (OPC-656)

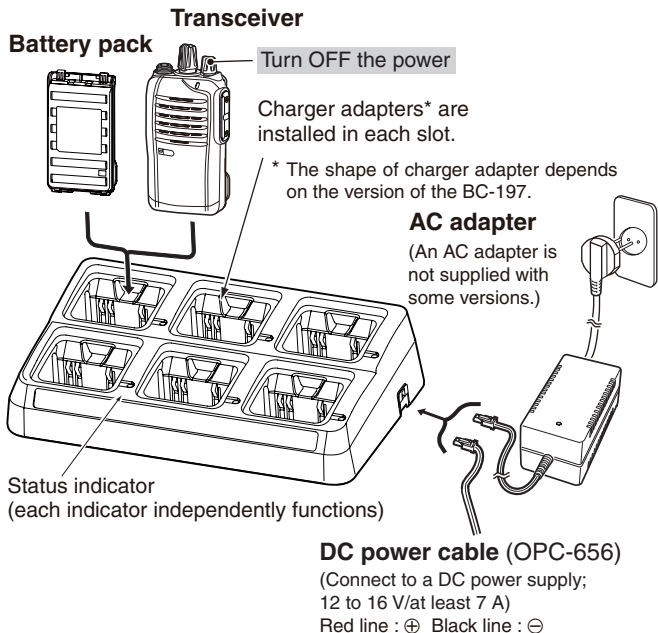

There are two types of BC-197 chargers for the IC-F3102D or IC-F4102D; one is for Ni-MH batteries, and the other is for Li-ion batteries.

Before you purchase a BC-197, check the type of battery you are using, and then be sure to choose the suitable charger.

5

<b>BC-197 Charger Type</b>	<b>Chargeable Battery</b>
<b>With AD-120* charger adapters</b>	BP-264 Ni-MH battery
<b>With AD-121* charger adapters</b>	BP-265 Li-ion battery

\* The type of the charger adapter, AD-120 or AD-121 is printed on the inside bottom of the charger adapter, and the type of battery it holds is printed on the top right corner of the adapter.

## 5 BATTERY CHARGING

### **IMPORTANT:**

Ensure the tabs on the battery pack are correctly aligned with the guide rails inside the charger.

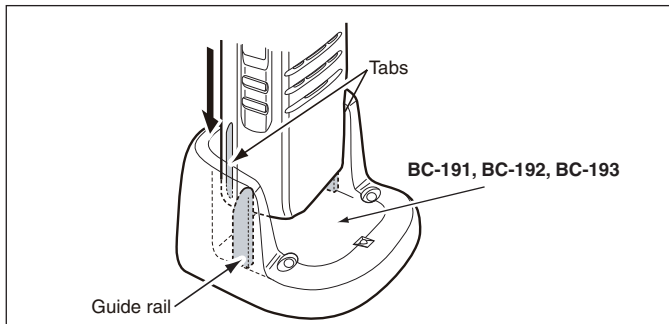



## ■ Optional battery case (BP-263)

When using the optional battery case, install 6 × AA (LR6) size alkaline batteries, as illustrated below.

- ① Remove the battery case, if it is attached. (pp. 3, 4)
- ② Install 6 × AA (LR6) size alkaline batteries.
  - Install only alkaline batteries.
  - Be sure to observe the correct polarity.

5

6

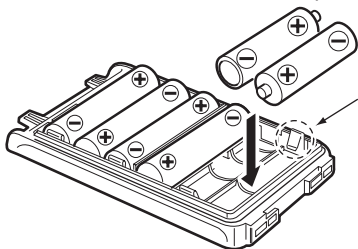

**Be careful!** The negative terminals of the battery case protrude from the body, so pay attention not to injure your fingers when inserting the batteries.

- ③ Attach the battery case. (pp. 3, 4)

### CAUTION:

- When installing batteries, make sure they are all the same brand, type and capacity. Also, do not mix new and old batteries together.
- Keep the battery terminals clean. It's a good idea to clean the battery terminals once a week.
- Never incinerate used battery cells since internal battery gas may cause them to rupture.
- Never expose a detached battery case to water. If the battery case gets wet, be sure to wipe it dry before using it.
- Never use batteries whose insulated cover is damaged.

**NOTE:** When the optional battery case is attached, the battery type must be selected as “Battery case operation” when turning the transceiver ON. Ask your dealer for details. (p. 12)

# 7 OPTIONS

## ◇ BATTERY PACK

Battery pack	Voltage	Capacity	Battery life*1	
<b>BP-263</b>	Battery case for AA (LR6) × 6 alkaline		__*2	
<b>BP-264</b>	7.2 V	1400 mAh (typ.)	VHF	12 hrs.
			UHF	11.3 hrs.
<b>BP-265</b>	7.4 V	1900 mAh (min.) 2000 mAh (typ.)	VHF	17.5 hrs.
			UHF	16.1 hrs.

\*1 When the power save function is turned ON, and the operating time is calculated under the following conditions;

TX : RX : standby = 5 : 5 : 90

\*2 The average operating time depends on the alkaline cells used.

## ◇ BELT CLIPS

### • **MB-124** BELT CLIP

Exclusive alligator-type belt clip.

## ◇ CHARGERS

### • **BC-191** DESKTOP CHARGER + **BC-123S** AC ADAPTER

For rapid charging of the Ni-MH battery pack. An AC adapter is supplied with the charger, depending on the version.

Charging time period: approximately 2 hours for the BP-264.

### • **BC-192** DESKTOP CHARGER + **BC-147S** AC ADAPTER

For regular charging of the Ni-MH battery pack. An AC adapter is supplied with the charger, depending on the version.

Charging time period: approximately 16 hours for the BP-264.

### • **BC-193** DESKTOP CHARGER + **BC-123S** AC ADAPTER

For rapid charging of the Li-ion battery pack. An AC adapter is supplied with the charger, depending on the version.

Charging time period: approximately 2.5 hours for the BP-265.

• **BC-197 MULTI-CHARGER**

For rapid simultaneously charging of up to six battery packs. An AC adapter may be supplied with the charger, depending on the version. There are two types of BC-197 chargers for the IC-F3102D/IC-F4102D.

BC-197 Charger Type	Chargeable Battery	Charging time
With AD-120*	BP-264 Ni-MH battery	Approx. 2 hrs.
With AD-121*	BP-265 Li-ion battery	Approx. 2.5 hrs.

\*Either AD-120 or AD-121 charger adapters are installed in the BC-197, depending on the chargeable battery pack.

◇ **DC POWER CABLES**

• **CP-23L CIGARETTE LIGHTER CABLE**

Allows charging of the battery pack through a 12 V cigarette lighter socket. (For BC-191/BC-193)

• **OPC-515L/OPC-656 DC POWER CABLE**

For charging of the battery packs using a 12 V DC power source instead of the AC adapter.

(OPC-515L for BC-191/BC-192/BC-193: OPC-656 for BC-197)

◇ **ANTENNAS**

• **FA-SC73US/FA-SC56VS/FA-SC57VS STUBBY ANTENNAS**

FA-SC73US : 450–490 MHz      FA-SC56VS : 150–162 MHz

FA-SC57VS : 160–174 MHz

• **FA-SC25U/FA-SC57U/FA-SC72U/**

**FA-SC25V/FA-SC55V ANTENNAS**

FA-SC25U : 400–430 MHz      FA-SC57U : 430–470 MHz

FA-SC72U : 470–520 MHz      FA-SC25V : 136–155 MHz

FA-SC55V : 146–174 MHz

• **FA-SC61VC/FA-SC61UC CUT ANTENNAS**

FA-SC61VC : 136–174 MHz      FA-SC61UC : 380–520 MHz

### ◇ OTHER OPTIONS

- **AD-98FSC** ANTENNA CONNECTOR CONVERTER  
Allows you to connect an external antenna with a BNC connector.
- **HM-158L/HM-159L** SPEAKER-MICROPHONE  
Combination speaker-microphone that provides convenient operation while hanging the transceiver on your belt.
- **HM-171GP** SPEAKER-MICROPHONE  
GPS speaker-microphone for BISS and Digital modes operation.
- **HS-94/HS-95/HS-97** HEADSET + **OPC-2004** PLUG ADAPTER CABLE  
HS-94 : Ear hook type  
HS-95 : Neck-arm type  
HS-97 : Throat microphone  
OPC-2004 : Allows you to connect the HS-94/HS-95/HS-97 to the transceiver. After connection, the VOX function can be used.
- **SP-27** TUBE EARPHONE  
Provides clear audio in noisy environments.

Approved Icom optional equipment is designed for optimal performance when used with an Icom transceiver.

Icom is not responsible for the destruction or damage to an Icom transceiver in the event the Icom transceiver is used with equipment that is not manufactured or approved by Icom.

Some options may not be available in some countries. Please ask your dealer for details.

## ■ VOX function

The transceiver has a VOX function, which allows you hands-free operation.

An optional headset (HS-94/HS-95/HS-97) and a plug adapter cable (OPC-2004) are additionally required for operation.

- The VOX (voice operated transmission) function starts transmitting when you speak into the microphone, without needing to push the PTT switch; then, automatically returns to receive when you stop speaking.

### ◇ Optional unit connection

- ① Rotate [VOL] to turn the transceiver power OFF.
- ② Remove the jack cover. (p. 4)
- ③ Connect the optional headset (HS-94, HS-95 or HS-97) and OPC-2004 as described below.

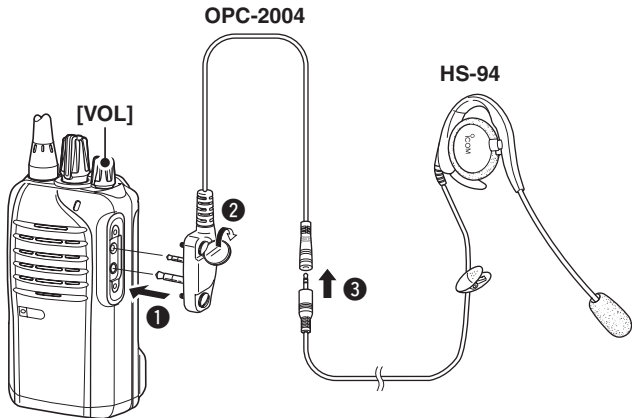

### ◇ Turning the VOX function ON or OFF

The VOX function can be turned ON or OFF when turning the transceiver power ON.

- ① Rotate [VOL] to turn the transceiver power OFF.
- ② Set [ROTARY SELECTOR] to any channel other than Channel 16.
- ③ While holding down [PTT] and [Upper], rotate [VOL] to turn ON the power to switch the VOX function ON or OFF.
  - One beep sounds when the VOX function is turned OFF.
  - Two beeps sound when the VOX function is turned ON.

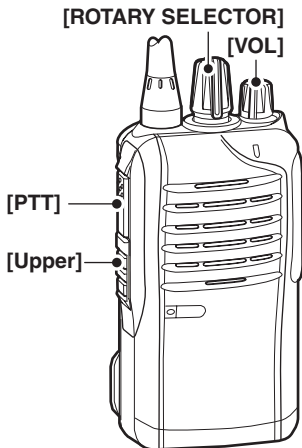

/// **NOTE:** This operation may not be available, depending on the presetting. Ask your dealer for details.

## ◇ Setting the VOX gain

The VOX sensitivity level can be adjusted from 1 (minimum) to 10 (maximum).

- ① Connect the optional headset (HS-94, HS-95 or HS-97) and OPC-2004. (p. 46)
- ② Rotate [VOL] to turn the transceiver power OFF.
- ③ Set [ROTARY SELECTOR] to Channel 16.
- ④ While holding down [PTT] and [Upper], rotate [VOL] to turn ON the power and enter the VOX gain adjustment mode.
- ⑤ Push [Upper] to increase, or push [Lower] to decrease the VOX gain while speaking into the optional headset.
  - The adjustable range is 1 (minimum) to 10 (maximum).
  - A beep sounds after pushing [Upper] or [Lower].  
If the level is set on 1 or 10, an error beep sounds after pushing. Therefore, you can determine the current level setting by the type of beep that sounds.
- ⑥ Rotate [VOL] to turn the power OFF, then ON to exit the VOX gain adjustment mode.

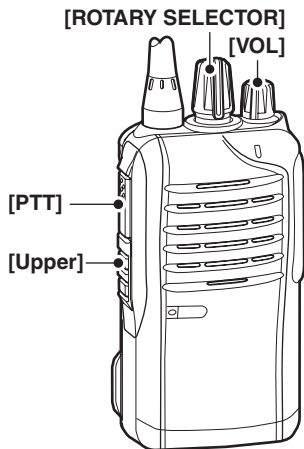

### NOTE:

- This operation may not be available, depending on the presetting. Ask your dealer for details.
- Set the microphone gain before setting the VOX gain. (p. 18)

## 8

## COUNTRY CODE LIST

## • ISO 3166-1

	Country	Codes		Country	Codes
1	Austria	AT	18	Liechtenstein	LI
2	Belgium	BE	19	Lithuania	LT
3	Bulgaria	BG	20	Luxembourg	LU
4	Croatia	HR	21	Malta	MT
5	Czech Republic	CZ	22	Netherlands	NL
6	Cyprus	CY	23	Norway	NO
7	Denmark	DK	24	Poland	PL
8	Estonia	EE	25	Portugal	PT
9	Finland	FI	26	Romania	RO
10	France	FR	27	Slovakia	SK
11	Germany	DE	28	Slovenia	SI
12	Greece	GR	29	Spain	ES
13	Hungary	HU	30	Sweden	SE
14	Iceland	IS	31	Switzerland	CH
15	Ireland	IE	32	Turkey	TR
16	Italy	IT	33	United Kingdom	GB
17	Latvia	LV			









Count on us!

< Intended Country of Use >

AT BE CY CZ DK EE  
FI FR DE GR HU IE  
IT LV LT LU MT NL  
PL PT SK SI ES SE  
GB IS LI NO CH BG  
RO TR HR

A-6891D-1EU-①

Printed in Japan

© 2011 Icom Inc.

Printed on recycled paper with soy ink.

Icom Inc.

1-1-32 Kamiminami, Hirano-ku, Osaka 547-0003, Japan

# ABOUT CE



## DECLARATION OF CONFORMITY

We Icom Inc. Japan  
1-1-32, Kamiminami, Hirano-ku  
Osaka 547-0003, Japan

Declare on our sole responsibility that this equipment complies with the essential requirements of the Radio and Telecommunications Terminal Equipment Directive, 1999/5/EC, and that any applicable Essential Test Suite measurements have been performed.

**Kind of equipment:** VHF TRANSCEIVER

**Type-designation:** IC-F3102D

136-174 MHz 6.25 kHz/12.5 kHz/25 kHz  
136-174 MHz 6.25 kHz/12.5 kHz/20 kHz

**Version (where applicable):**

This compliance is based on conformity with the following harmonised standards, specifications or documents:

- i) EN 300 086-2 V1.3.1 (2010-06)
- ii) EN 300 113-2 V1.4.2 (2009-11)
- iii) EN 300 219-2 V1.1.1 (2001-03)
- iv) EN 301 166-2 V1.2.3 (2009-11)
- v) EN 301 489-1 V1.8.1 (2008-04)
- vi) EN 301 489-5 V1.3.1 (2002-08)
- vii) EN 60950-1:2006/A1:2010



Bad Soden 3rd Jun. 2011  
Place and date of issue

Icom (Europe) GmbH  
Communication Equipment  
Auf der Krautweide 24,  
65812 Bad Soden am Taunus,  
Germany  
Authorized representative name

Y. Furukawa  
General Manager

Signature

**Icom Inc.**



Versions of the IC-F3102D which display the “CE” symbol on the serial number label, comply with the essential requirements of the European Radio and Telecommunication Terminal Directive 1999/5/EC.



This warning symbol indicates that this equipment operates in non-harmonised frequency bands and/or may be subject to licensing conditions in the country of use. Be sure to check that you have the correct version of this radio or the correct programming of this radio, to comply with national licensing requirement.

# ABOUT CE



## DECLARATION OF CONFORMITY

We Icom Inc. Japan  
1-1-32, Kamiminami, Hirano-ku  
Osaka 547-0003, Japan

Declare on our sole responsibility that this equipment complies with the essential requirements of the Radio and Telecommunications Terminal Equipment Directive, 1999/5/EC, and that any applicable Essential Test Suite measurements have been performed.

**Kind of equipment:** UHF TRANSCEIVER

**Type-designation:** IC-F4102D

400-470 MHz 6.25 kHz/12.5 kHz/25 kHz  
400-470 MHz 6.25 kHz/12.5 kHz/20 kHz

**Version (where applicable):**

This compliance is based on conformity with the following harmonised standards, specifications or documents:

- i) EN 300 086-2 V1.3.1 (2010-06)
- ii) EN 300 113-2 V1.4.2 (2009-11)
- iii) EN 300 219-2 V1.1.1 (2001-03)
- iv) EN 301 166-2 V1.2.3 (2009-11)
- v) EN 301 489-1 V1.8.1 (2008-04)
- vi) EN 301 489-5 V1.3.1 (2002-08)
- vii) EN 60950-1:2006/A1:2010



Bad Soden 8th Jul. 2011  
Place and date of issue

Icom (Europe) GmbH  
Communication Equipment  
Auf der Krautweide 24,  
65812 Bad Soden am Taunus,  
Germany

Authorized representative name

Y. Furukawa  
General Manager

Signature

Icom Inc.



Versions of the IC-F4102D which display the “CE” symbol on the serial number label, comply with the essential requirements of the European Radio and Telecommunication Terminal Directive 1999/5/EC.



This warning symbol indicates that this equipment operates in non-harmonised frequency bands and/or may be subject to licensing conditions in the country of use. Be sure to check that you have the correct version of this radio or the correct programming of this radio, to comply with national licensing requirement.